

Date: Ref. No.: Job Name:
 Economizer Model: Representative:
 Boiler Model:

Bul.#90112

CCE

**PERFORMANCE
AND
DIMENSION DATA**

Temperatures:

Flue Gas:
 A In:
 B Out:
 Feedwater:
 C In:
 D Out:

Dimensions:

E:
 F:
 G: Connection
 H: Diameter
 Weight:
 Heating Surface:

FINTUBE MATERIALS:

- ALFUSE: ALUMINUM FIN METALLURGICALLY BONDED TO TP316L STAINLESS STEEL TUBE
- ALFUSE: ALUMINUM FIN METALLURGICALLY BONDED TO DUPLEX STAINLESS STEEL TUBE
- CARBON STEEL FIN BRAZE/WELDED TO SA178 GRA CARBON STEEL TUBE

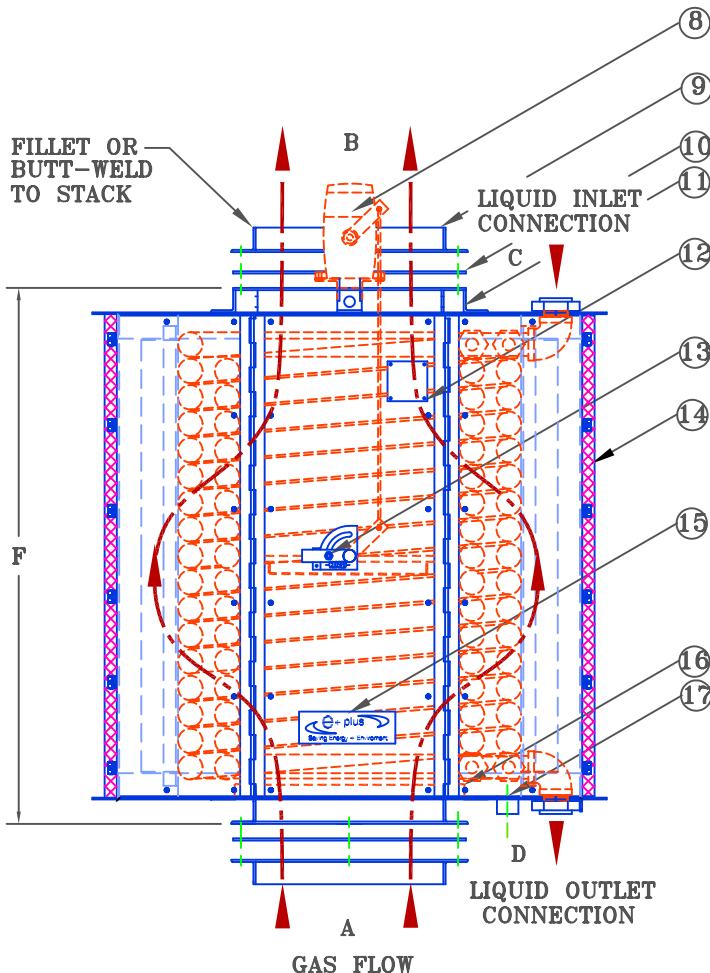
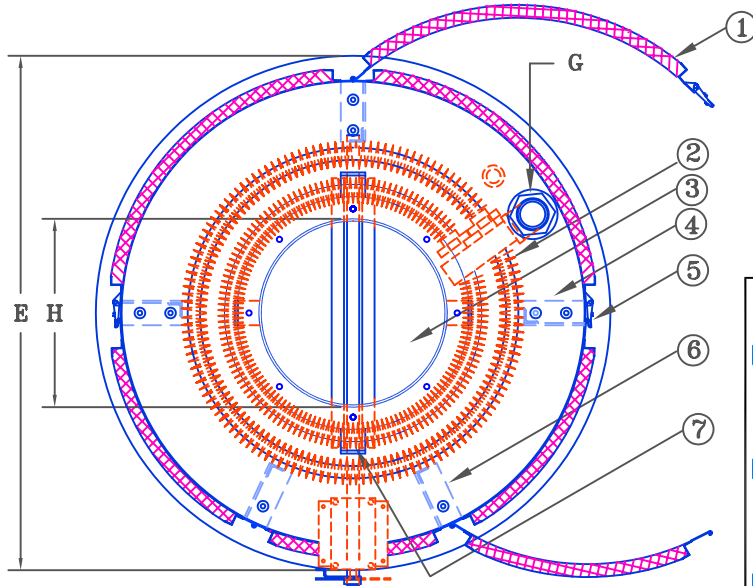

PARTS LIST:

(SEE DESIGN DATA FOR CONSTRUCTION)

1. HINGED STAINLESS STEEL DOUBLE WALL ACCESS PANELS
2. FIN-TUBE ASSEMBLY (SINGLE ROW)
3. STAINLESS FLUE GAS BYPASS
4. LID ASSEMBLY
5. SELF-LOCKING TENSION LATCH
6. SUPPORT BRACE ASSEMBLY
7. DAMPER SHAFT
8. MODULATING DAMPER ACTUATOR (OPTIONAL)
9. MATING FLANGES (2) INCLUDED
10. MATING FLANGE GASKETS (2) INCLUDED
11. LIFTING LUG
12. ASME STAMP
13. MANUAL BYPASS ADJUSTING ASSY.
14. 2" THICKNESS FACTORY INSULATION
15. MANUFACTURER LOGO
16. DRAIN CATCH RING
17. 1" NPT CONDENSATE DRAIN